

# ARBOGA



## A 2608 M

	Ø 25 / 28 mm		<b>50Hz</b>	<b>60Hz</b>
			105-210 350-700 445-890 1460-2900	130-260 420-840 535-1070 1740-3480
	130 mm		0,65/0,90 kW	0,80/1,10 kW
			<b>mm/r</b>	<b>inch/r</b>
	M16 / M20		0,10	0,004
			0,15	0,006
			0,22	0,009
			0,30	0,012
	MK 3			
	500 x 400 mm			



195

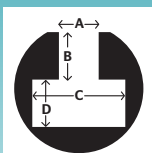

A 14,5 +/- 0,8 mm  
B 13 mm  
C 26 mm  
D 12 mm

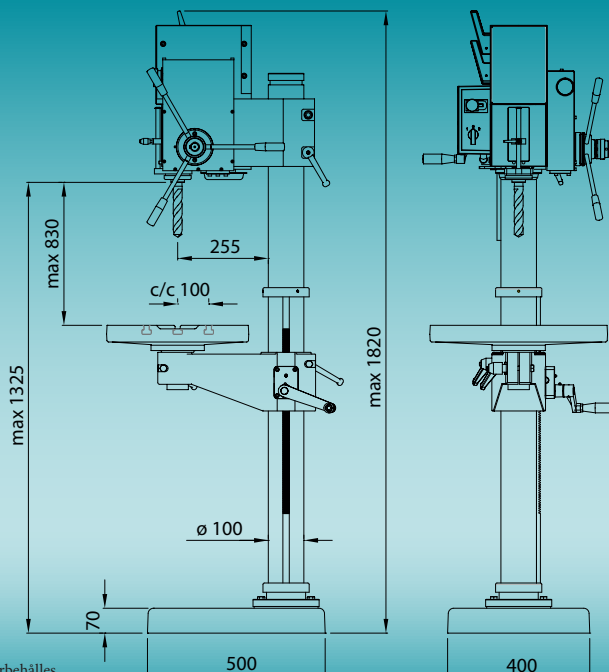

**MSC**   
Machinery  
Scandinavia

# Tillbehör A 2608 M

Spare parts/Zubehör

ARBOGA  
2011



T25095



T25000

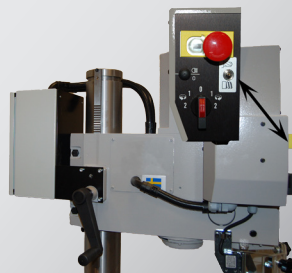

T25001



T25003



T25006



T25009

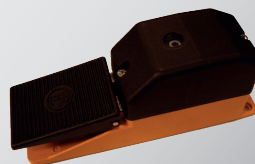

T25010

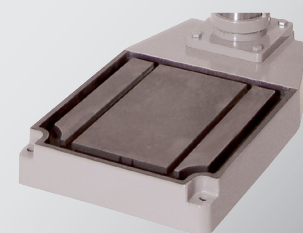

T25011



T25012



T25013



T25021

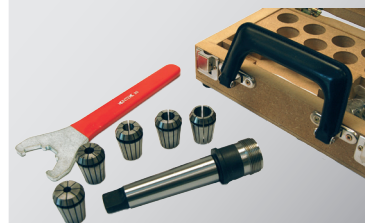

T25U42



T30040 0-13 mm



T30041 3-16 mm

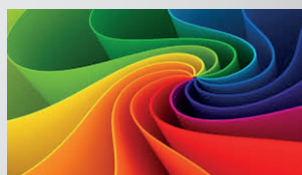

TFARGO

**MSC**   
**Machinery  
Scandinavia**

Machinery Scandinavia AB  
570 83 Rosenfors, Sweden  
Tel +46 495 49 700  
Fax + 46 495 207 30  
E-mail: sales@mscab.se  
[www.arbogamachinery.com](http://www.arbogamachinery.com)